

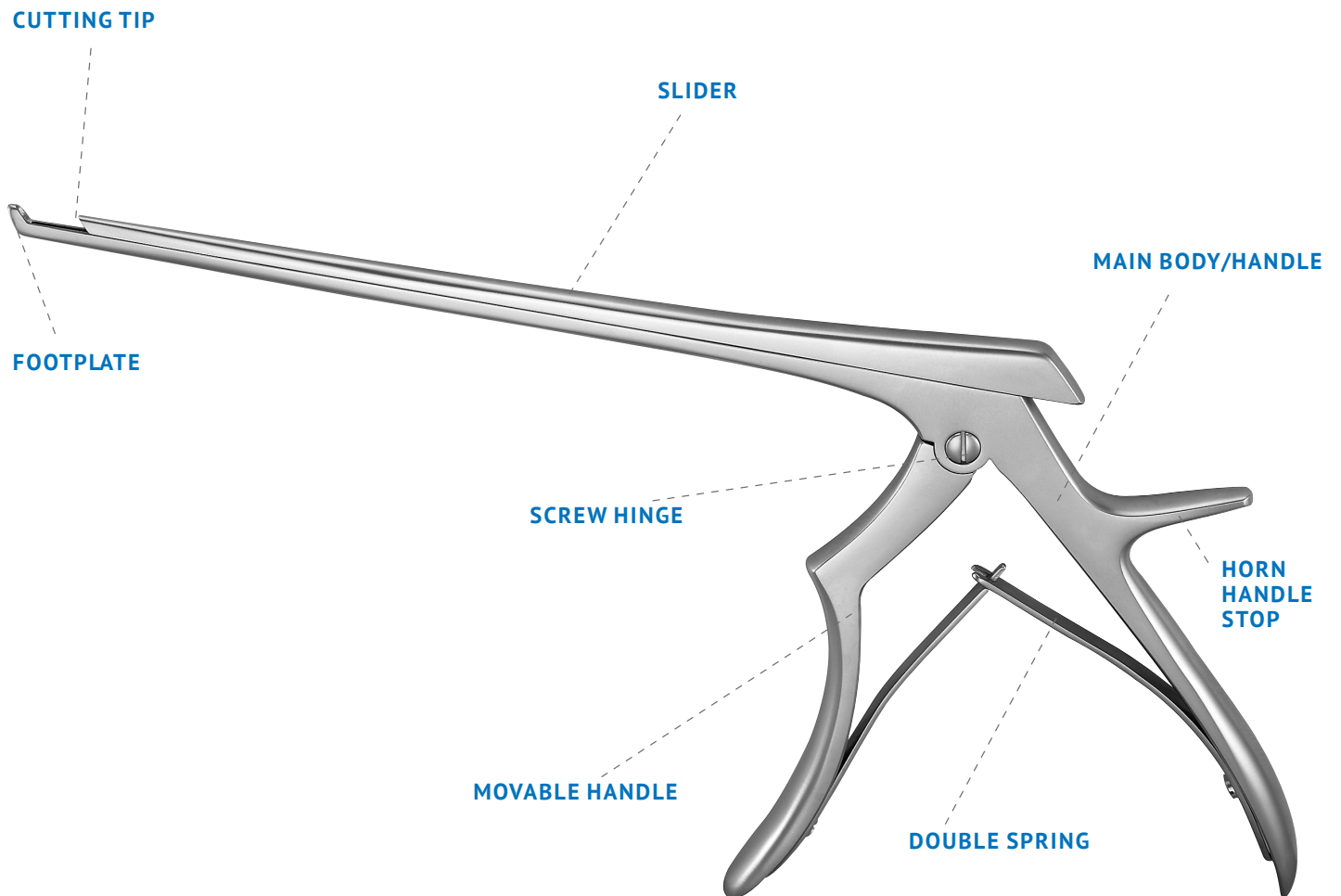

KERRISON DESIGN
Standard, Detachable, Silicone
and Customized Bone Punches

TERMS



STANDARD

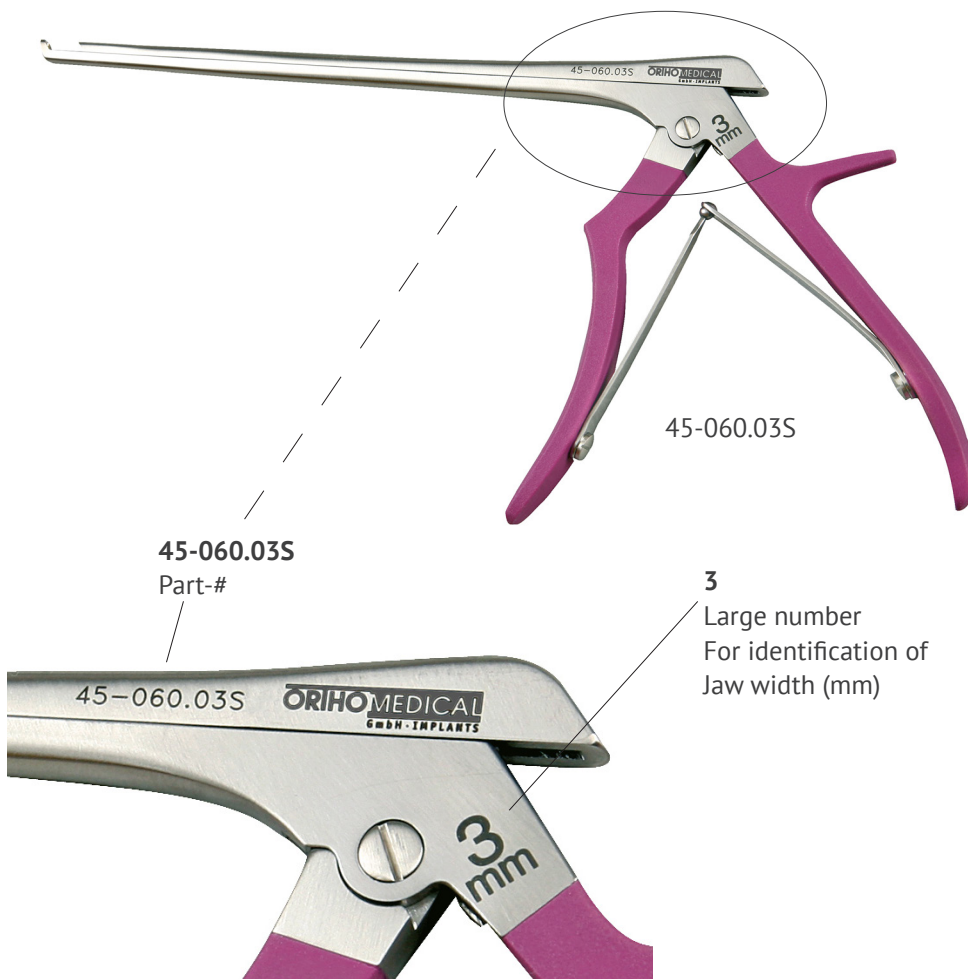
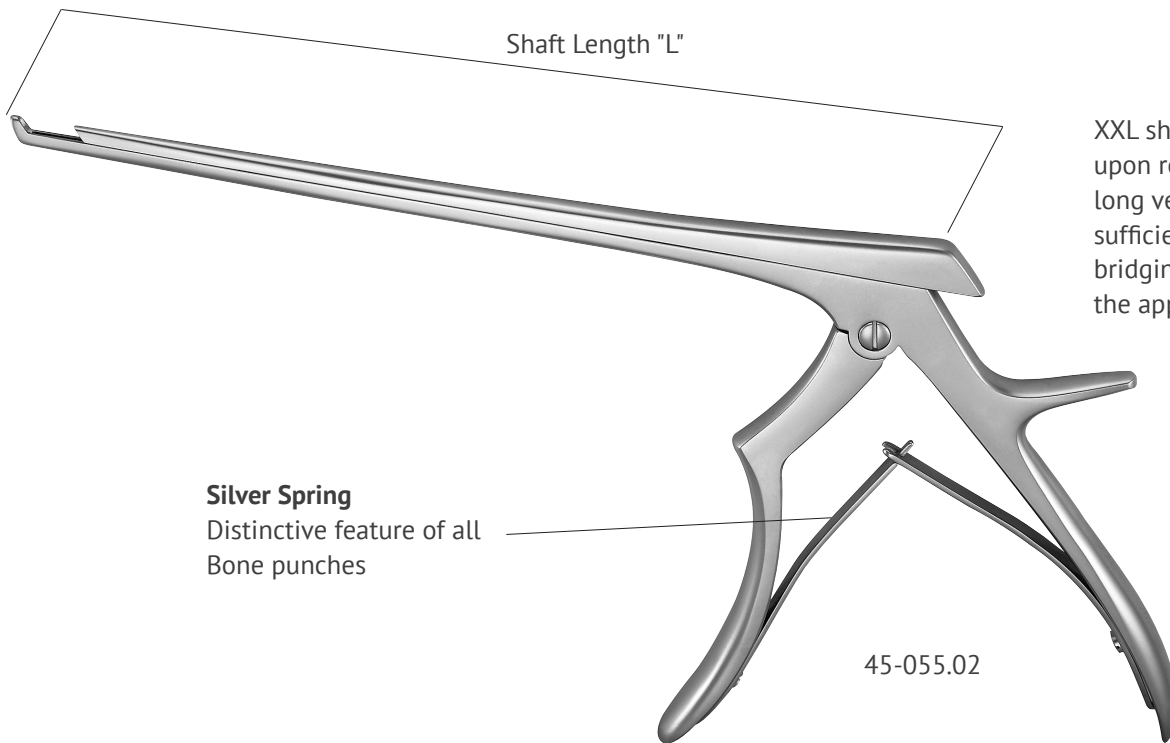

STANDARD

External T-Slot with Ejector



Ejector

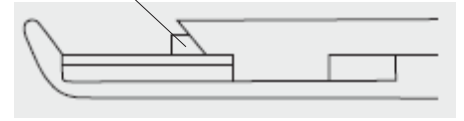

40° upwards

Ejector

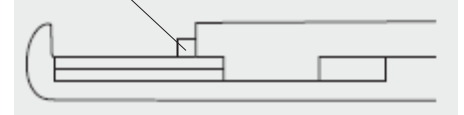

90° upwards

< Standard jaw opening >
8 - 12 mm



< Large jaw opening >
approx. 16 mm



Offer a wider jaw opening
compared to standard
bone punches

ORTHO-MEDICAL's Footplate design
available in **Standard** and **Thin** Footplate
size



Punches with a thin footplate are used exclusively
for removing small portions of bone and soft tissue.

ANATOMY

Spine is divided into four different parts:

- Cervical spine with seven vertebrae: C1 – C7
- Thoracic spine with twelve vertebrae: TH1 – TH12
- Lumbar spine with five vertebrae: L1 – L5
- Sacrum with five fused vertebrae: S1 – S5

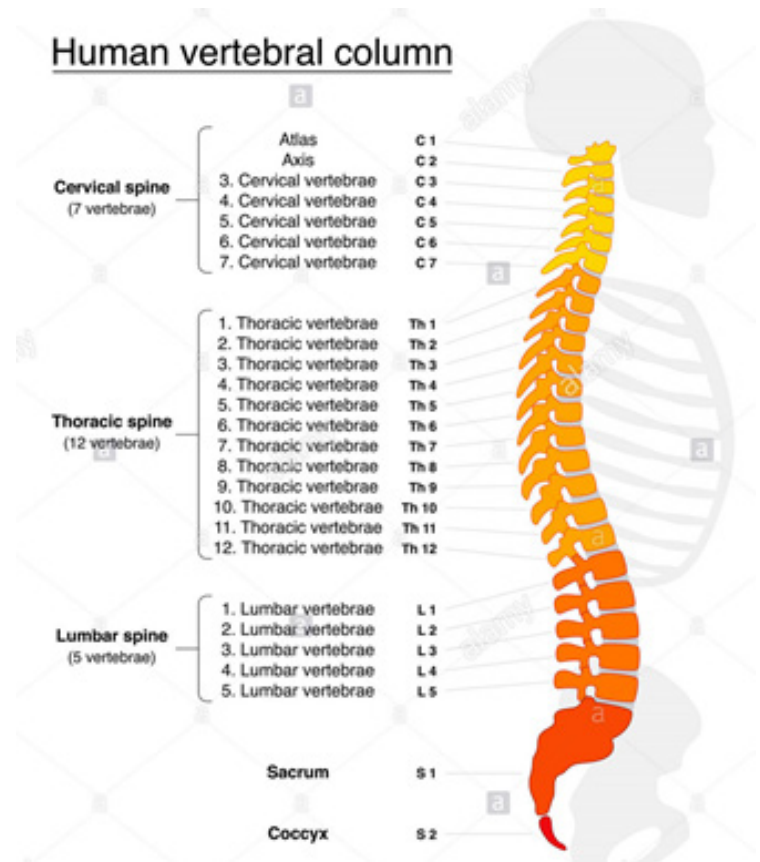

Anatomy - intervertebral discs

- The intervertebral discs are as in the name is recognizable, lie between two vertebral bodies and are firmly attached to them. The outer fibrous ring and the inner nucleus together form the intervertebral disc.
- The herniation: in which parts of the nucleus pulposus can escape through the damaged fibrous ring of the intervertebral discs.

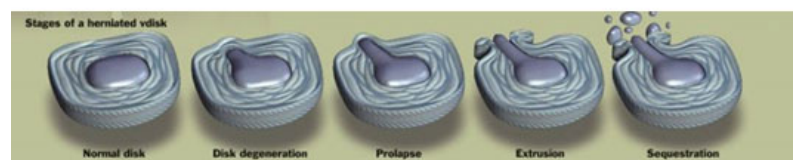
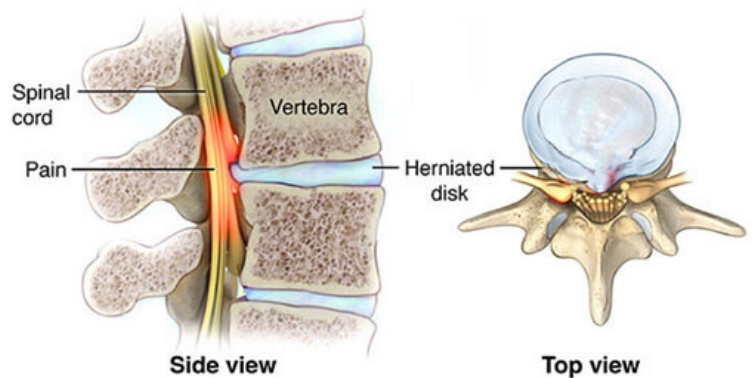

FERRIS-SMITH-KERRISON

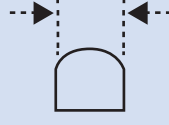
JAW ORIENTATION 40°, UPWARDS CUTTING 		FOOTPLATE	DESIGN
Shaft Length "L"	Jaw Size	Standard	Thin*
6" / 15 cm	1,0 mm	45-050.01	45-050.01D
	2,0 mm	45-050.02	45-050.02D
	3,0 mm	45-050.03	45-050.03D
	4,0 mm	45-050.04	45-050.04D
	5,0 mm	45-050.05	45-050.05D
	6,0 mm	45-050.06	45-050.06D
7" / 18 cm	1,0 mm	45-055.01	45-055.01D
	2,0 mm	45-055.02	45-055.02D
	3,0 mm	45-055.03	45-055.03D
	4,0 mm	45-055.04	45-055.04D
	5,0 mm	45-055.05	45-055.05D
	6,0 mm	45-055.06	45-055.06D
8" / 20 cm	1,0 mm	45-060.01	45-060.01D
	2,0 mm	45-060.02	45-060.02D
	3,0 mm	45-060.03	45-060.03D
	4,0 mm	45-060.04	45-060.04D
	5,0 mm	45-060.05	45-060.05D
	6,0 mm	45-060.06	45-060.06D
12" / 30 cm	1,0 mm	45-061.01	45-061.01D
	2,0 mm	45-061.02	45-061.02D
	3,0 mm	45-061.03	45-061.03D
	4,0 mm	45-061.04	45-061.04D
	5,0 mm	45-061.05	45-061.05D
	6,0 mm	45-061.06	45-061.06D

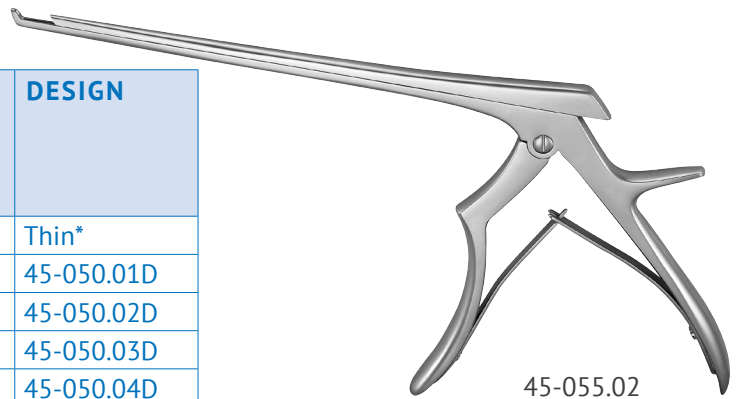

45-055.02

*
Punches with a thin footplate are used exclusively for removing small portions of bone and soft tissue.

FERRIS-SMITH-KERRISON

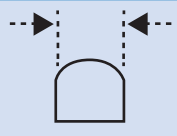
JAW ORIENTATION 90°, UPWARDS CUTTING		FOOTPLATE	DESIGN
Shaft Length "L"	Jaw Size	Standard	Thin*
6" / 15 cm	1,0 mm	45-035.01	45-035.01D
	2,0 mm	45-035.02	45-035.02D
	3,0 mm	45-035.03	45-035.03D
	4,0 mm	45-035.04	45-035.04D
	5,0 mm	45-035.05	45-035.05D
	6,0 mm	45-035.06	45-035.06D
7" / 18 cm	1,0 mm	45-040.01	45-040.01D
	2,0 mm	45-040.02	45-040.02D
	3,0 mm	45-040.03	45-040.03D
	4,0 mm	45-040.04	45-040.04D
	5,0 mm	45-040.05	45-040.05D
	6,0 mm	45-040.06	45-040.06D
8" / 20 cm	1,0 mm	45-045.01	45-045.01D
	2,0 mm	45-045.02	45-045.02D
	3,0 mm	45-045.03	45-045.03D
	4,0 mm	45-045.04	45-045.04D
	5,0 mm	45-045.05	45-045.05D
	6,0 mm	45-045.06	45-045.06D

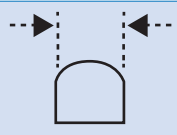
JAW ORIENTATION 90°, DOWNWARDS CUTTING		FOOTPLATE	DESIGN
Shaft Length "L"	Jaw Size	Standard	Thin*
6" / 15 cm	1,0 mm	45-065.01	45-065.01D
	2,0 mm	45-065.02	45-065.02D
	3,0 mm	45-065.03	45-065.03D
	4,0 mm	45-065.04	45-065.04D
	5,0 mm	45-065.05	45-065.05D
	6,0 mm	45-065.06	45-065.06D
7" / 18 cm	1,0 mm	45-070.01	45-070.01D
	2,0 mm	45-070.02	45-070.02D
	3,0 mm	45-070.03	45-070.03D
	4,0 mm	45-070.04	45-070.04D
	5,0 mm	45-070.05	45-070.05D
	6,0 mm	45-070.06	45-070.06D
8" / 20 cm	1,0 mm	45-075.01	45-075.01D
	2,0 mm	45-075.02	45-075.02D
	3,0 mm	45-075.03	45-075.03D
	4,0 mm	45-075.04	45-075.04D
	5,0 mm	45-075.05	45-075.05D
	6,0 mm	45-075.06	45-075.06D

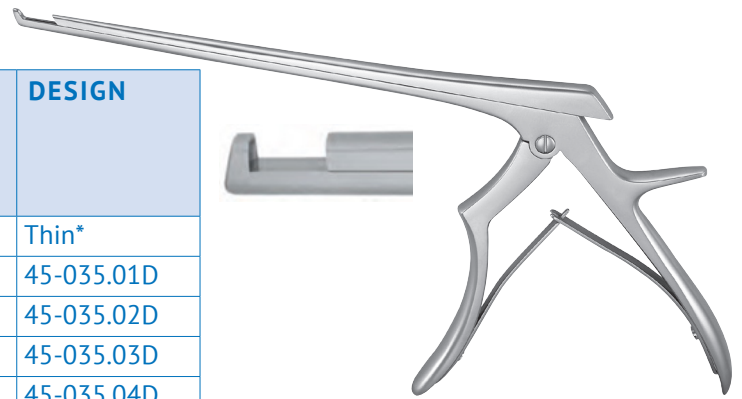

*
Punches with a thin footplate are used exclusively for removing small portions of bone and soft tissue.

FERRIS-SMITH-KERRISON LARGE OPENING 16MM

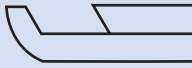
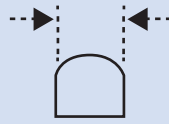
JAW ORIENTATION 40°, UPWARDS CUTTING 		FOOTPLATE	DESIGN
Shaft Length "L"	Jaw Size	Standard	Thin*
6" / 15 cm	1,0 mm	45-112.01	-
	2,0 mm	45-112.02	-
	3,0 mm	45-112.03	-
	4,0 mm	45-112.04	-
	5,0 mm	45-112.05	-
	6,0 mm	45-112.06	-
7" / 18 cm	1,0 mm	45-117.01	-
	2,0 mm	45-117.02	-
	3,0 mm	45-117.03	-
	4,0 mm	45-117.04	-
	5,0 mm	45-117.05	-
	6,0 mm	45-117.06	-
8" / 20 cm	1,0 mm	45-157.01	45-157.01D
	2,0 mm	45-157.02	45-157.02D
	3,0 mm	45-157.03	45-157.03D
	4,0 mm	45-157.04	45-157.04D
	5,0 mm	45-157.05	45-157.05D
	6,0 mm	45-157.06	45-157.06D

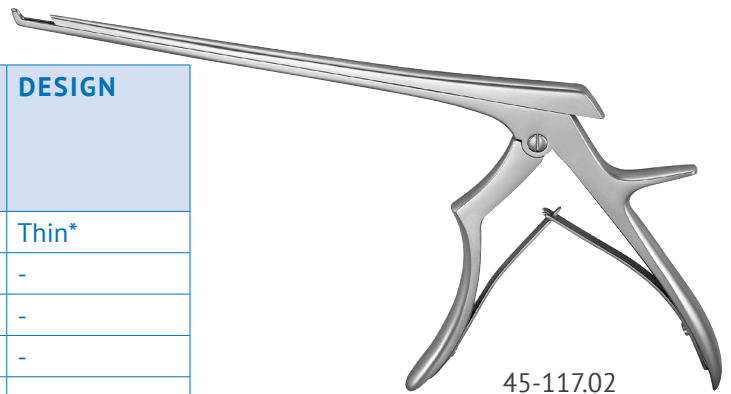

*
Punches with a thin footplate are used exclusively for removing small portions of bone and soft tissue.

FERRIS-SMITH-KERRISON WITH EXTERNAL T-SLOT & EJECTOR

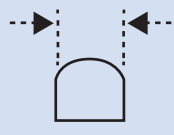
JAW ORIENTATION 40°, UPWARDS CUTTING		FOOTPLATE DESIGN
Shaft Length "L"	Jaw Size	Standard
6" / 15 cm	2,0 mm	45-050.102
	3,0 mm	45-050.103
	4,0 mm	45-050.104
	5,0 mm	45-050.105
	6,0 mm	45-050.106
7" / 18 cm	2,0 mm	45-055.102
	3,0 mm	45-055.103
	4,0 mm	45-055.104
	5,0 mm	45-055.105
	6,0 mm	45-055.106
8" / 20 cm	2,0 mm	45-060.102
	3,0 mm	45-060.103
	4,0 mm	45-060.104
	5,0 mm	45-060.105
	6,0 mm	45-060.106

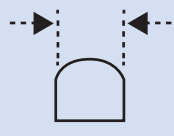

45-055.103

JAW ORIENTATION 90°, UPWARDS CUTTING		FOOTPLATE DESIGN
Shaft Length "L"	Jaw Size	Standard
6" / 15 cm	2,0 mm	45-035.102
	3,0 mm	45-035.103
	4,0 mm	45-035.104
	5,0 mm	45-035.105
	6,0 mm	45-035.106
7" / 18 cm	2,0 mm	45-040.102
	3,0 mm	45-040.103
	4,0 mm	45-040.104
	5,0 mm	45-040.105
	6,0 mm	45-040.106
8" / 20 cm	2,0 mm	45-045.102
	3,0 mm	45-045.103
	4,0 mm	45-045.104
	5,0 mm	45-045.105
	6,0 mm	45-045.106

SILICONE

- Biocompatible silicone coated stainless steel handles help to prevent slippage and provide a secure and comfortable grip.
- Made from German stainless steel with silicone coated handles.
- Colored handles provide easy bite size recognition.
- Available in five standard colors according to bite size (red, blue, lavender, turquoise, green).
- Silicone has excellent resistance to alkaline, saline and acidic solutions.
- Non-fading vibrant colors withstand repeated autoclaving.
- Forward and up bite styles available from stock.
- Quality verified and guaranteed by ORTHO-MEDICAL GmbH.

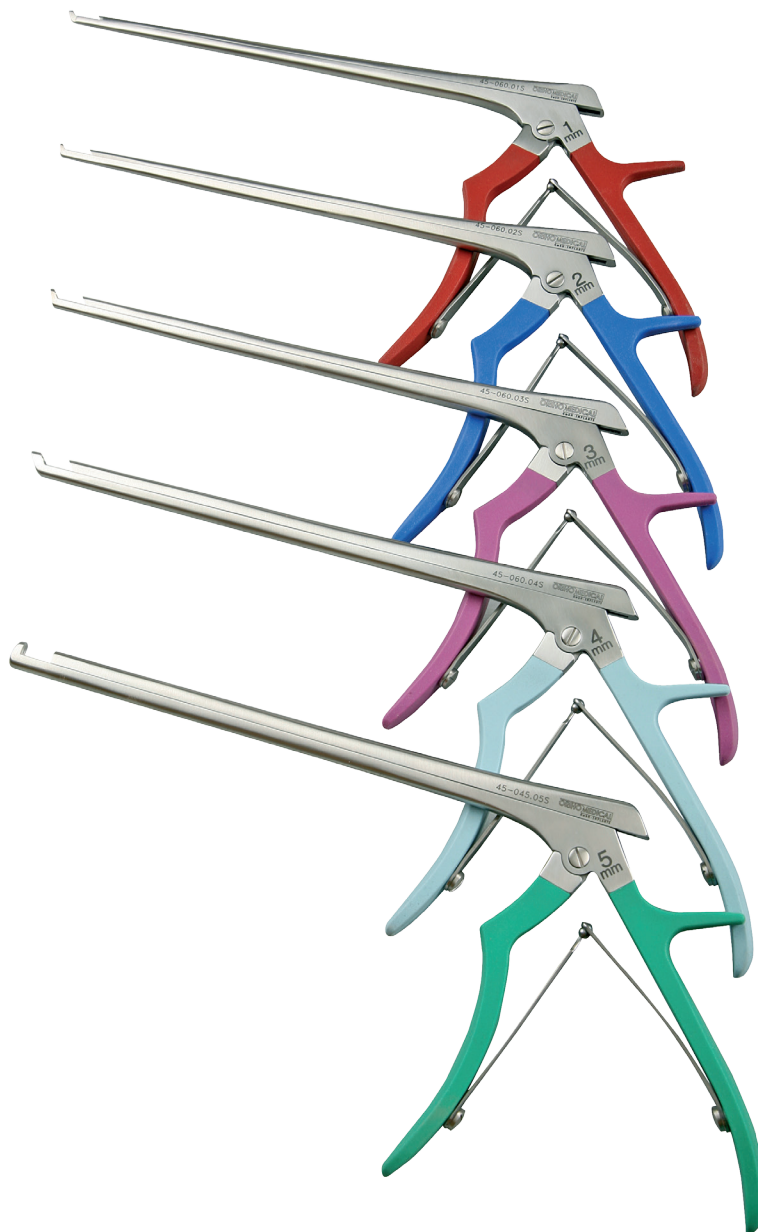

FERRIS-SMITH-KERRISON WITH SILICONE HANDLE

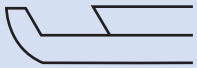
JAW ORIENTATION 40°, UPWARDS CUTTING 		FOOTPLATE	DESIGN	
Shaft Length "L"	Jaw Size	Standard	Thin*	Handle Color
6" / 15 cm	1,0 mm	45-050.01S	45-050.01DS	red
	2,0 mm	45-050.02S	45-050.02DS	blue
	3,0 mm	45-050.03S	45-050.03DS	lavender
	4,0 mm	45-050.04S	45-050.04DS	turquoise
	5,0 mm	45-050.05S	45-050.05DS	green
7" / 18 cm	1,0 mm	45-055.01S	45-055.01DS	red
	2,0 mm	45-055.02S	45-055.02DS	blue
	3,0 mm	45-055.03S	45-055.03DS	lavender
	4,0 mm	45-055.04S	45-055.04DS	turquoise
	5,0 mm	45-055.05S	45-055.05DS	green
8" / 20 cm	1,0 mm	45-060.01S	45-060.01DS	red
	2,0 mm	45-060.02S	45-060.02DS	blue
	3,0 mm	45-060.03S	45-060.03DS	lavender
	4,0 mm	45-060.04S	45-060.04DS	turquoise
	5,0 mm	45-060.05S	45-060.05DS	green

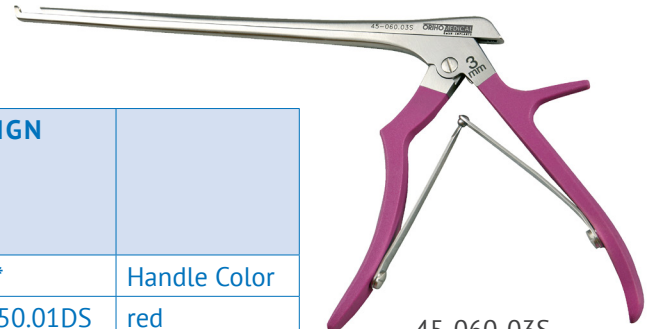

45-060-03S

*
Punches with a thin footplate are used exclusively for removing small portions of bone and soft tissue.

FERRIS-SMITH-KERRISON WITH SILICONE HANDLE

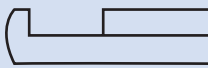
JAW ORIENTATION 90°, UPWARDS CUTTING 		FOOTPLATE	DESIGN	
Shaft Length "L"	Jaw Size	Standard	Thin*	Handle Color
6" / 15 cm	1,0 mm	45-035.01S	45-035.01DS	red
	2,0 mm	45-035.02S	45-035.02DS	blue
	3,0 mm	45-035.03S	45-035.03DS	lavender
	4,0 mm	45-035.04S	45-035.04DS	turquoise
	5,0 mm	45-035.05S	45-035.05DS	green
7" / 18 cm	1,0 mm	45-040.01S	45-040.01DS	red
	2,0 mm	45-040.02S	45-040.02DS	blue
	3,0 mm	45-040.03S	45-040.03DS	lavender
	4,0 mm	45-040.04S	45-040.04DS	turquoise
	5,0 mm	45-040.05S	45-040.05DS	green
8" / 20 cm	1,0 mm	45-045.01S	45-045.01DS	red
	2,0 mm	45-045.02S	45-045.02DS	blue
	3,0 mm	45-045.03S	45-045.03DS	lavender
	4,0 mm	45-045.04S	45-045.04DS	turquoise
	5,0 mm	45-045.05S	45-045.05DS	green

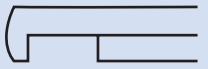
JAW ORIENTATION 90°, DOWNWARDS CUTTING 		FOOTPLATE	DESIGN	
Shaft Length "L"	Jaw Size	Standard	Thin*	Handle Color
6" / 15 cm	1,0 mm	45-065.01S	45-065.01DS	red
	2,0 mm	45-065.02S	45-065.02DS	blue
	3,0 mm	45-065.03S	45-065.03DS	lavender
	4,0 mm	45-065.04S	45-065.04DS	turquoise
	5,0 mm	45-065.05S	45-065.05DS	green
7" / 18 cm	1,0 mm	45-070.01S	45-070.01DS	red
	2,0 mm	45-070.02S	45-070.02DS	blue
	3,0 mm	45-070.03S	45-070.03DS	lavender
	4,0 mm	45-070.04S	45-070.04DS	turquoise
	5,0 mm	45-070.05S	45-070.05DS	green
8" / 20 cm	1,0 mm	45-075.01S	45-075.01DS	red
	2,0 mm	45-075.02S	45-075.02DS	blue
	3,0 mm	45-075.03S	45-075.03DS	lavender
	4,0 mm	45-075.04S	45-075.04DS	turquoise
	5,0 mm	45-075.05S	45-075.05DS	green

*
Punches with a thin footplate are used exclusively
For removing small portions of bone and soft tissue.

SPECIAL EDITIONS

In addition to Standard Punches, ORTHO-MEDICAL offers a portfolio of special Bone Punches for almost every surgical discipline.

i.e. Bayonet-Shaped and Foraminotomy Punches

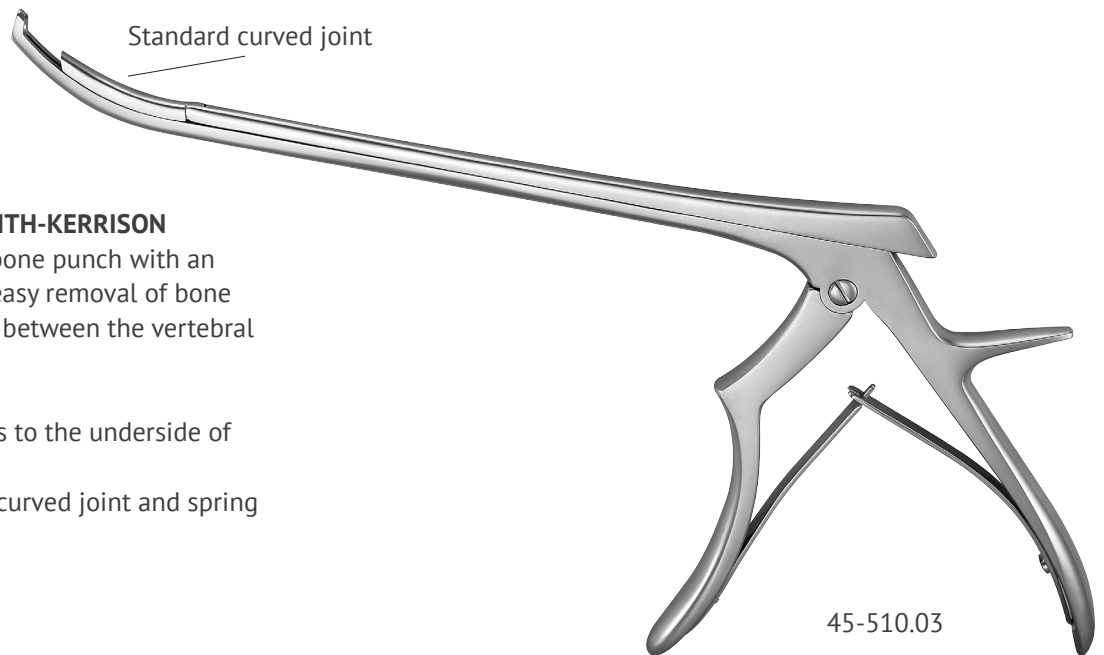

Foraminotomy FERRIS-SMITH-KERRISON

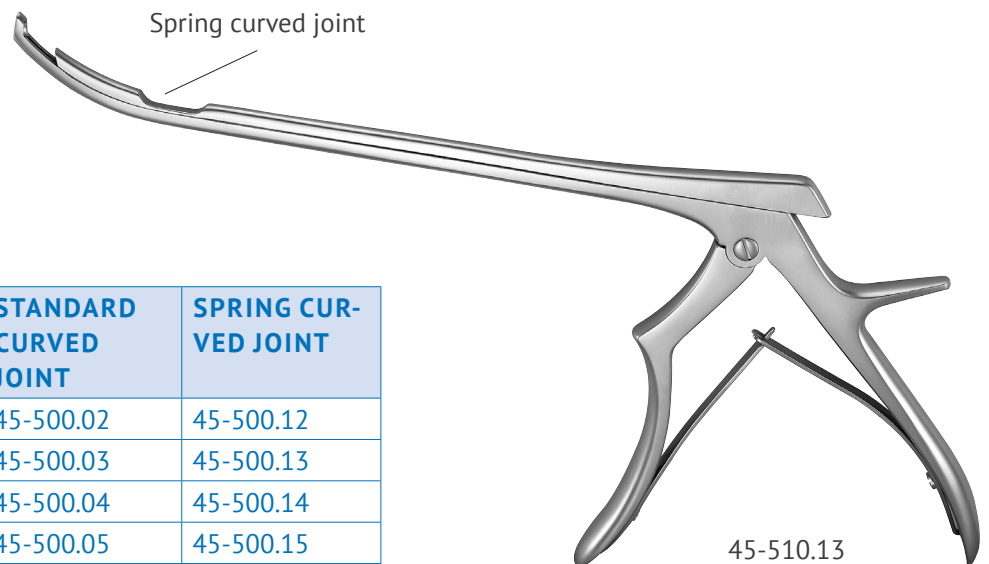

- Classic non-detachable bone punch with an upbiting curved jaw for easy removal of bone material, especially from between the vertebral arches.
- 40° upwards cutting
- Provides improved access to the underside of the foramen
- Available with Standard curved joint and spring curved joint



SHAFT LENGTH "L"	JAW SIZE	STANDARD CURVED JOINT	SPRING CURVED JOINT
7" / 18 cm	2,0 mm	45-500.02	45-500.12
	3,0 mm	45-500.03	45-500.13
	4,0 mm	45-500.04	45-500.14
	5,0 mm	45-500.05	45-500.15
8" / 20 cm	6,0 mm	45-500.06	45-500.16
	2,0 mm	45-510.02	45-510.12
	3,0 mm	45-510.03	45-510.13
	4,0 mm	45-510.04	45-510.14
	5,0 mm	45-510.05	45-510.15
	6,0 mm	45-510.06	45-510.16

SPECIAL EDITIONS

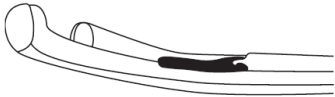

		TIP	ORIENTATION
Shaft Length "L"	Jaw Size	70° curved left 	70° curved right 
8" / 20 cm	3,0 mm	45-509.53	45-510.53
	4,0 mm	45-509.54	45-510.54

SPECIAL EDITIONS

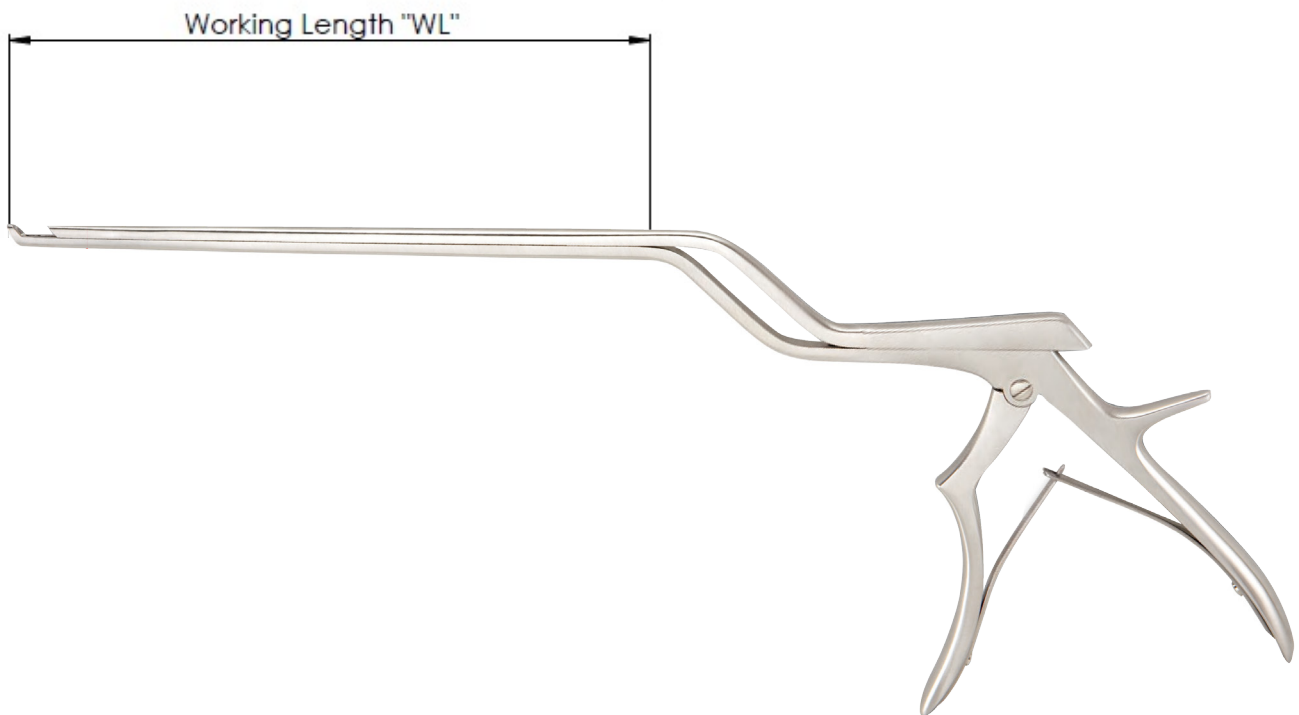

Bayonet-Shaped FERRIS-SMITH-KERRISON

- Classic non-detachable bayonet-shaped bone punch for improved vision over the shaft and increased visibility of surgical site.
- Easy use through a retractor tube for MIS procedures.

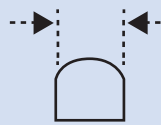
JAW ORIENTATION 40°, UPWARDS CUTTING		FOOTPLATE	DESIGN
Working Length „WL“	Jaw Size	Standard	
6" / 15 cm	1,0 mm	45-050.01BAY	
	2,0 mm	45-050.02BAY	
	3,0 mm	45-050.03BAY	
	4,0 mm	45-050.04BAY	
	5,0 mm	45-050.05BAY	
7" / 18 cm	1,0 mm	45-055.01BAY	
	2,0 mm	45-055.02BAY	
	3,0 mm	45-055.03BAY	
	4,0 mm	45-055.04BAY	
	5,0 mm	45-055.05BAY	

CERAMIC

Individually made for our customers

Our CERAMIC coated instruments offer the following advantages:

- Smooth action due to less surface friction
- Scratch resistance
- Maximum durability
- Non reflective
- Higher corrosion resistance
- Aesthetical
- Validated biocompatibility
- Easy to clean due to improved surface structure

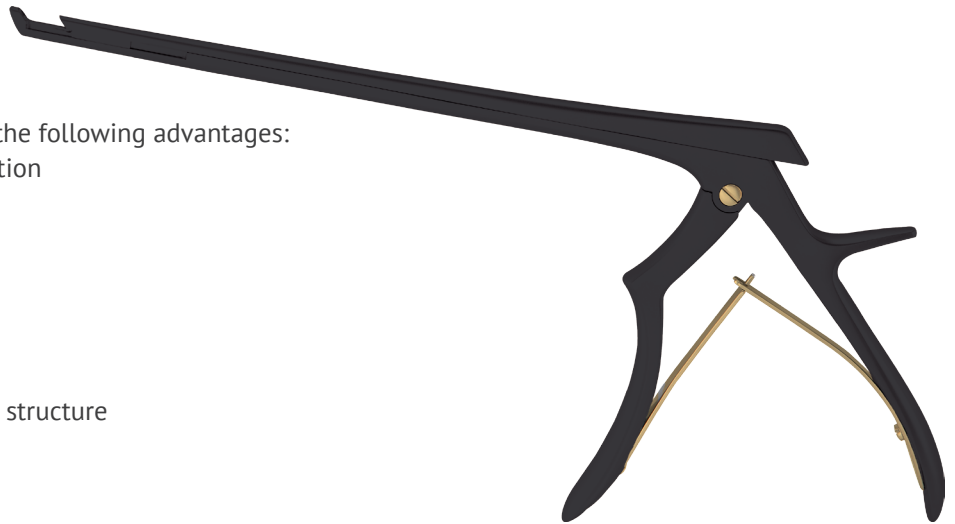

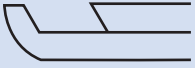
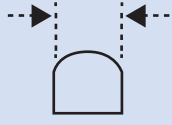
JAW ORIENTATION 40°, UPWARDS CUTTING 		FOOTPLATE	DESIGN
Shaft Length "L"	Jaw Size	Standard	Thin*
7" / 18 cm	1,0 mm	45-055.01BL	45-055.01DBL
	2,0 mm	45-055.02BL	45-055.02DBL
	3,0 mm	45-055.03BL	45-055.03DBL
	4,0 mm	45-055.04BL	45-055.04DBL
	5,0 mm	45-055.05BL	45-055.05DBL
	6,0 mm	45-055.06BL	45-055.06DBL
8" / 20 cm	1,0 mm	45-060.01BL	45-060.01DBL
	2,0 mm	45-060.02BL	45-060.02DBL
	3,0 mm	45-060.03BL	45-060.03DBL
	4,0 mm	45-060.04BL	45-060.04DBL
	5,0 mm	45-060.05BL	45-060.05DBL
	6,0 mm	45-060.06BL	45-060.06DBL

*

Punches with a thin footplate are used exclusively for removing small portions of bone and soft tissue.

ORLOS CLEAN CONCEPT

Open for easy and complete cleaning.

In most spinal punches, tissue and debris can collect and remain trapped between the main body and slider. The ORTHO-MEDICAL Detachable Kerrison Punch has a slider that opens in order to allow for easy and complete cleaning inside the main body.

- Punch remains in one piece when opened so there are no loose instrument components.
- Forward angle provides precise and controlled cutting action.
- Thin foot plate on 1mm-6mm bite sizes.
- Bone ejector is incorporated into the design of 2mm-6mm bite sizes.
- Made from German stainless steel.
- Quality verified and guaranteed by ORTHO-MEDICAL.

DISASSEMBLY in 1 Step:



OPEN Position, for:

- Easy disassembly and assembly without tools
- Efficient cleaning and sterilization

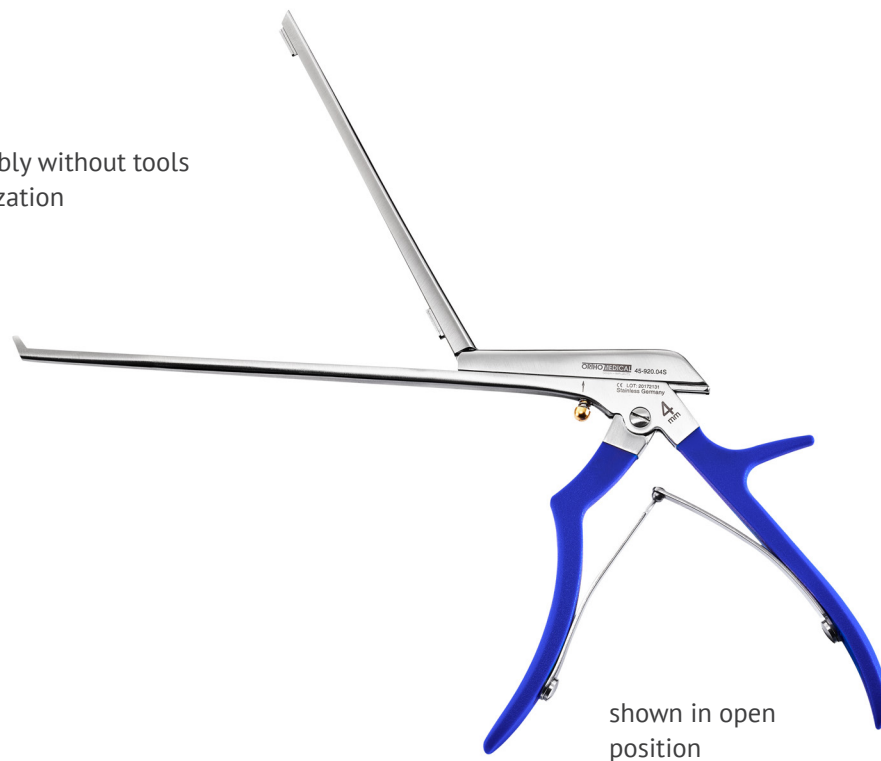

ORLOS CLEAN CONCEPT

TO CLOSE:

- Align and engage slider in grooves on main body
- Squeeze handle together - Punch locks automatically
- Release hold on handle
- Check instrument function to ensure slider is engaged properly

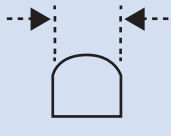
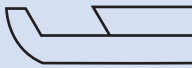

JAW ORIENTATION 40°, UPWARDS CUTTING		FOOTPLATE	DESIGN
			
Shaft Length "L"	Jaw Size	Standard	Thin
8" / 20 cm	2,0 mm	45-920.02S	45-920.02DS
	3,0 mm	45-920.03S	45-920.03DS
	4,0 mm	45-920.04S	45-920.04DS
	5,0 mm	45-920.05S	45-920.05DS
	6,0 mm	45-920.06S	45-920.06DS

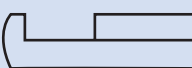
JAW ORIENTATION 90°, UPWARDS CUTTING		FOOTPLATE	DESIGN
			
Shaft Length "L"	Jaw Size	Standard	Thin*
8" / 20 cm	2,0 mm	45-921.02S	45-921.02DS
	3,0 mm	45-921.03S	45-921.03DS
	4,0 mm	45-921.04S	45-921.04DS
	5,0 mm	45-921.05S	45-921.05DS
	6,0 mm	45-921.06S	45-921.06DS

ORGANIZING & STERILIZATION SYSTEM

Available Colors of the lid



Lid perforated, only



Bottom not perforated



Size	Part-#	L (mm)	B (mm)	H (mm)	Color
1/2	60-520.20	285	280	200	Light Grey
	60-520.20B				Dark Blue
	60-520.20R				Red
	60-520.20G				Green
	60-520.20Y				Yellow
	60-520.20S				Black
1/1	60-504.20	580	280	200	Light Grey
	60-504.20B				Dark Blue
	60-504.20R				Red
	60-504.20G				Green
	60-504.20Y				Yellow
	60-504.20S				Black

RACK

60-595.10

ORLOS Kerrison Rack for 8 Instruments

- will fit into - 1/2 container with 20 cm min. height

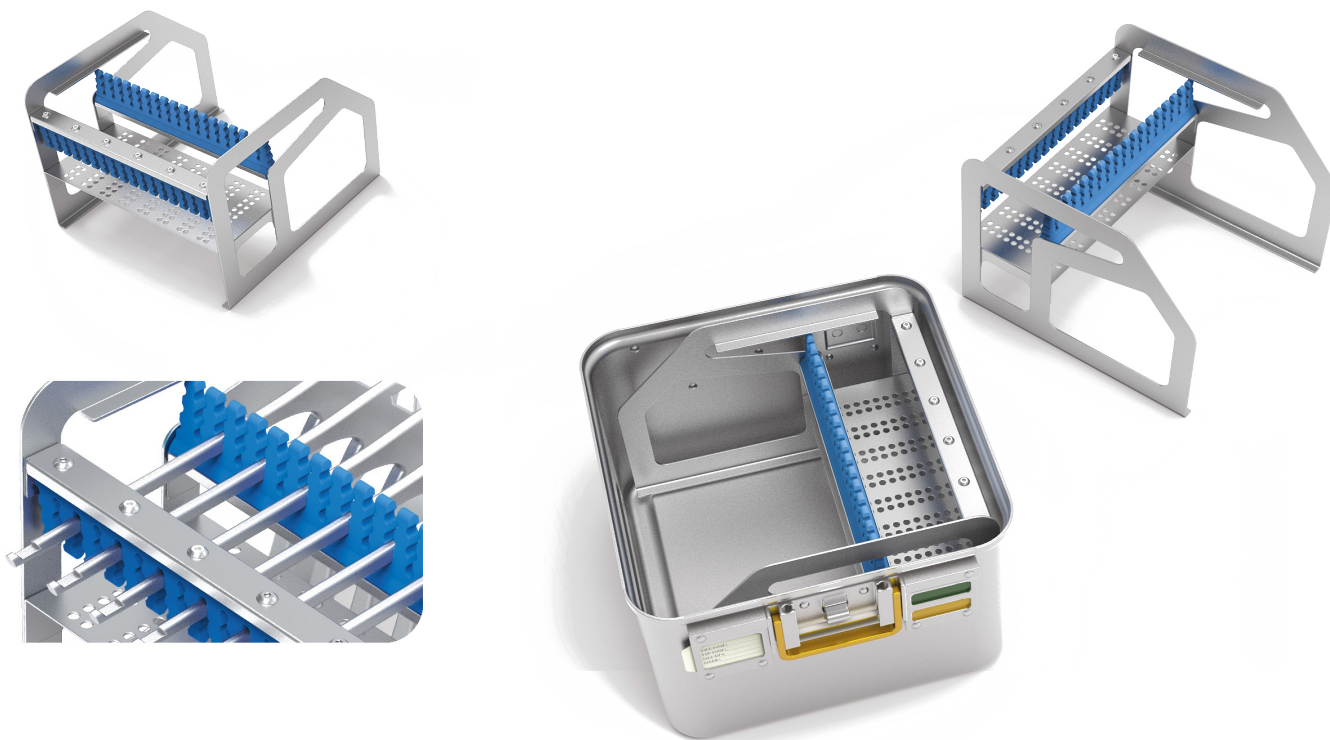

Organization and Protection of Bone Punches

Our ORTHO-MEDICAL Organization System is an advanced system of organizing, storing and protecting your Bone Punches during transportation and Sterilization.

- special Kerrison rack for all sizes
- protection increases instrument life-time, reducing replacement cost
- protection reduces cost of repairs & setting time
- protection against damage during transportation

60-595.03

Rack for 10 Kerrison punches

Fits into 1/2, 1/1 container,
height minimum 20,0 cm
facilitate firm and easy storage
during and after sterilization



CUSTOMIZED

ORTHO-MEDICAL (OM) is more than a source for standard off-the-shelf instruments. We will also create custom instruments, according to your drawings and specifications, in a timely and economical manner.

Forged or machined instruments can be quoted. Instruments are made of stainless steel according to German or U.S. steel standards. Most OM instruments are made from German stainless steel type 1.4021 - equivalent to American steel type 420.

For an accurate quotation and delivery schedule, send us a sample, sketch or drawing.

Average lead time for custom instruments is 2-12 weeks, depending on complexity of quoted instruments and quantities.

From prototypes to full-run production, OM is committed to being a valuable business partner, always providing a real return on investment.

Instruments shown in this section are only a few examples of custom instruments produced.



OEM Capabilities

- ✓ Prototypes
- ✓ Trial and full run productions
- ✓ Forged or machined instrument production
- ✓ Contract manufacturing services – assembly
- ✓ Engineering support
- ✓ On-site product development
- ✓ 3D printing
- ✓ Custom marking of your logo and part number on instrument
- ✓ Custom labeling and custom packaging
- ✓ Products inspected and verified to your inspection procedures
- ✓ 100% medical devices
- ✓ Inventory control
- ✓ Certification according DIN EN ISO 13485:2016 | 93/42/EEC, annex II excluding 4

CUSTOMIZE HANDLE STYLE

Custom designs can be manufactured in a timely and economical manner. Handles shown on this page are standard styles and sizes. Each handle can be customized according to your specifications.

Your logo can be placed on the instrument.



Finger Ring Handle
Handle height: 4"



Ferris-Smith-Kerrison
Ring Handle
Handle height: 5"



Ferris-Smith-Kerrison
Handle
Handle height: 5"



Kerrison Handle
Handle height: 6"



Love-Kerrison Standard
Handle
Handle height: 6"



Love-Kerrison Handle
Handle height: 6"

CUSTOMIZE SHAFT LENGTH AND WORKING END

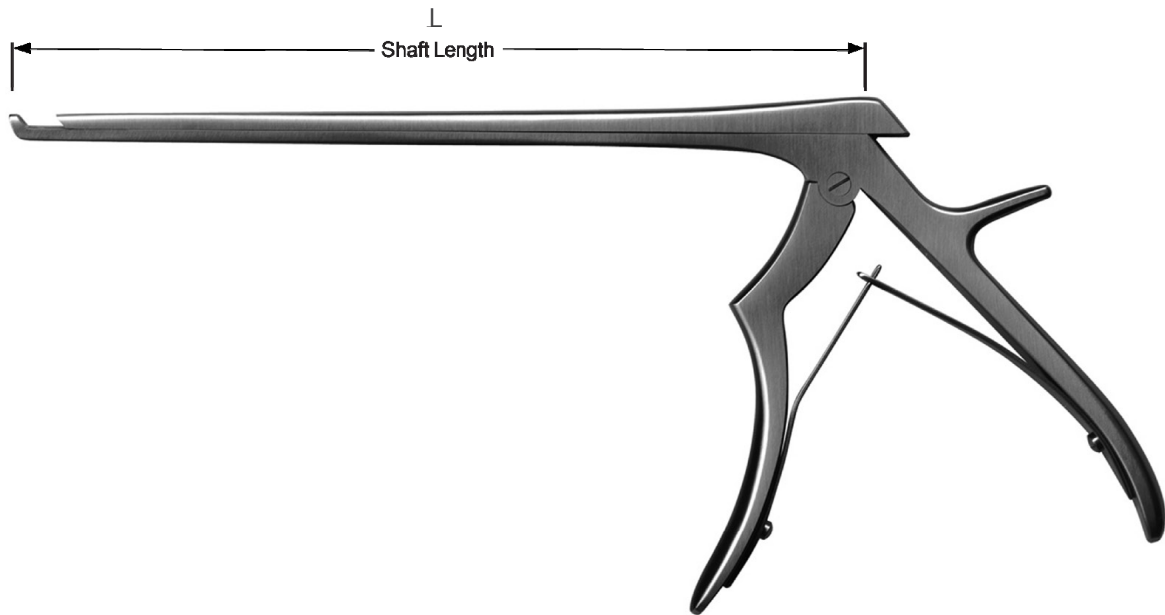

customize shaft style and additional coating



Straight shaft,
fenestrated cup
with serrated jaws

- Double fenestrated cup can be customized to your specifications.
- Straight, up, or down jaw bite styles provide precise cutting action.
 - Jaws can be serrated or non-serrated.
 - Custom options available upon request.

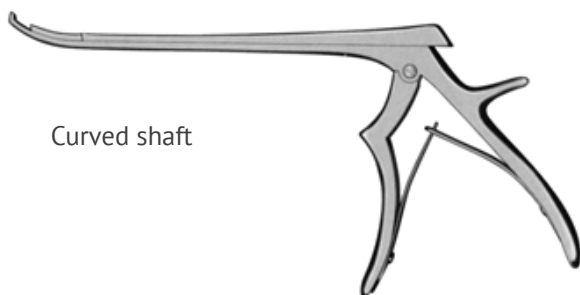

Curved shaft

- Curved shaft and forward angled foot plate make the underside of the foramen accessible. Hinge at working end of upper shaft enables a smooth cutting function.
- Curve can be customized to your specifications.
 - Curve angle options include slight, strong, left or right

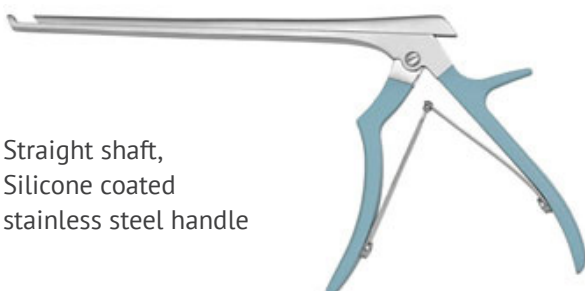

Straight shaft,
Silicone coated
stainless steel handle

- Biocompatible silicone coated handles help to prevent slippage and provide a secure grip.
- Colored handles provide easy bite size recognition.
 - Available in five standard colors according to bite size (red, blue, lavender, turquoise, green) or custom colors of your choice.
 - Silicone has excellent resistance to alkaline, saline and acidic solutions.
 - Non-fading vibrant colors withstand repeated autoclaving.

CUSTOMIZE WORKING ENDS



